

Contents

1	Data cable wiring.....	2	8	Fault finding	25
1.1	Data cable termination.....	3	8.1	DyNet bus issues	25
1.2	Standard RS-485 PIN outs	4	8.2	Electrical measurements.....	25
	DyNet-F/UTP-CABLE-LSZH.....	4	8.3	Unresponsive devices.....	25
	DyNet-SFLAT6-CABLE.....	4	8.4	DALI Bus Issues.....	26
	Cat 5e/6 Ethernet cable T568A	4	8.5	Advanced DALI Bus issues	26
	Cat 5e/6 Ethernet cable T568B	4	9	Fault finding with System Builder	27
	Dynalite pinout summary table	5	9.1	Trunk and Spur Messaging	27
1.3	DMX wiring.....	5	9.2	PDEG and PDDEG-S Logs	27
1.4	Recommended control cable types..	6	9.3	Legacy Devices.....	28
1.5	Devices on a single cable run	7	9.4	Virtual Machine.....	28
1.6	1-10V cabling	8	9.5	Unique Fade Times.....	28
1.7	DALI cabling.....	9	9.6	Debugging messages.....	28
	1.7.1 DALI topology	10	9.7	DALI Diagnostics.....	28
	1.7.2 Scaling DALI networks	10	10	Troubleshooting tables.....	29
2	Installing load controllers	11	10.1	Load Controller Issues.....	29
2.1	Circuit breakers	13	10.2	User Interface, Sensor and Dry Contact issues	30
3	Installing gateways.....	16	10.3	Touchscreen issues	30
4	Installing user interfaces	17	10.4	Third party system integration issues	31
4.1	Environmental sensor positioning.....	18	11	Pre-commissioning site visit	32
5	Installing sensors	20	11.1	Visit details	32
5.1	Motion detection positioning.....	20	11.2	Installation Checklist.....	32
5.2	Light regulation positioning	21	11.3	Site contacts.....	33
5.3	Inbuilt indicator LED	21			
6	Installing dry contact input devices.....	22			
6.1	DLLI8180 and DPMI940-DALI	22			
6.2	DDMIDC8.....	22			
7	Energising the System	23			
7.1	Power-up tests	23			
7.2	Default Preset Scenes	24			
7.3	Controller Service Switch	24			
7.4	Controller Service LED.....	24			

I Data cable wiring



Do NOT connect DALI or mains power to RS-485 DyNet data terminals.

1. The data cable is connected to all devices as per the project schematic following correct colour code and DyNet terminations. Devices may be wired in any order.
2. The recommended connection method is to 'daisy chain' devices in sequence, starting at the first device, then looping in and out of each device, with a single cable terminating at the last device. There should not be any branching, and only the first and last device should terminate a single cable, all other devices should terminate two cables.

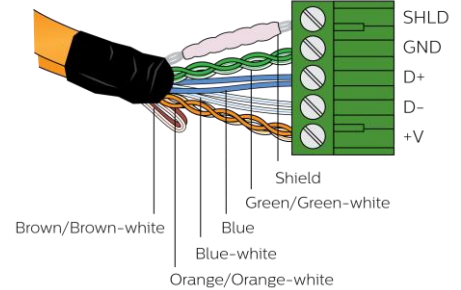

3. A data cable that is connected to an energised device is live. Do not cut or terminate live data cables.
4. The cable tail can be returned to the original distribution board. Ground wire and power wire (+V) can be connected in a loop but D+ and D- must NOT be connected in a loop. Do not connect power wire (+V) in a loop when network segments have multiple power supplies deployed, to ensure Network cable current limits are not exceeded.
5. Maximum allowed power supply rating and data cable current for any section of the network is the lowest of either 2 Amps or the cable rating per local wiring code or cable manufacturer specification. Where required, apply power wire (+V) segmentation per network design to prevent exceeding limits. Use only approved DyNet power supplies to ensure network reliability and safety.
6. The data cable should be segregated from mains cables by a minimum of 50 mm (2 in) for shielded cable and 300 mm (12 in) for unshielded cable or as per local wiring code specification (whichever is greater). If the data cable crosses over any mains cables, it should cross at 90°, whilst maintaining correct segregation. The wiring segregation distance may be reduced if either data cables, mains cables or both are fitted in separate grounded metal conduits.
7. On keypads and sensors, the Shield wires must be terminated into the SHLD terminal. Shield wires are automatically earthed on each controller. For controllers that do not have a shield terminal, the shield should be twisted together and taped to the cable sheath to maintain continuity.
8. The maximum recommended length for DyNet cables between two network bridges is 800 m (2620 ft). For cable runs over 300 m (1000 ft), (or baud rates over 9600 bps), a 120 Ohm, 2 W end-of-line resistor must be installed across the D+ and D- terminals of the DyNet connector strip on the first and last devices (similar to DMX).

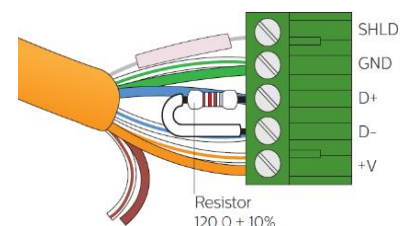
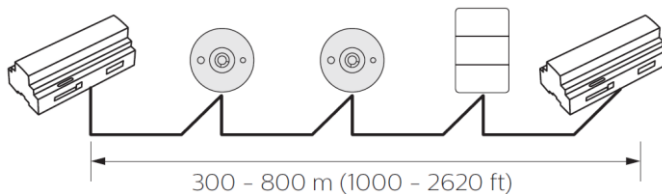

I.1 Data cable termination

1. Strip off outer jackets of cables being daisy chained.

Shielded cables only: Cut foil or braid flush to outer jacket. DO NOT cut drain (shield) wire.

2. Strip insulation from each of the conductors.

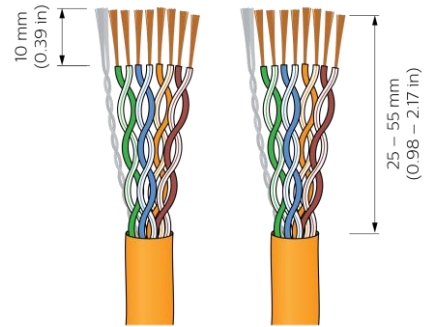

3. Bind the two cables around the end with electrical tape or use a cable tie (see final drawing).

4. Separate the blue and the blue-white wires from each other. Then combine them with the matching wires from the other cable; blue to blue and blue-white to blue-white.

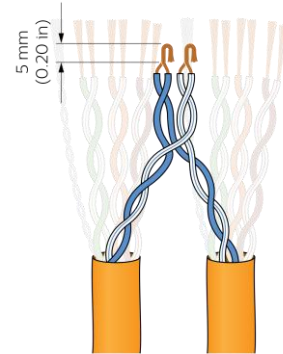

5. Twist remaining conductors ends with the matching-coloured wires and fold ends in half. Isolate the unused pair with a connector or tape.

6. Reuse a wire insulation offcut (or heat shrink tubing) and fit over drain wire.

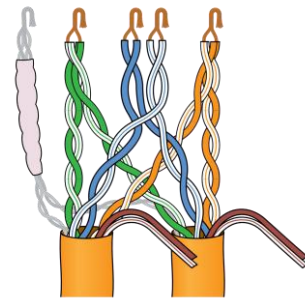

7. Terminate the wires on the pluggable screw terminal block. (If used, shrink the heat-shrink tubing)

8. Label or tag the cable appropriately.

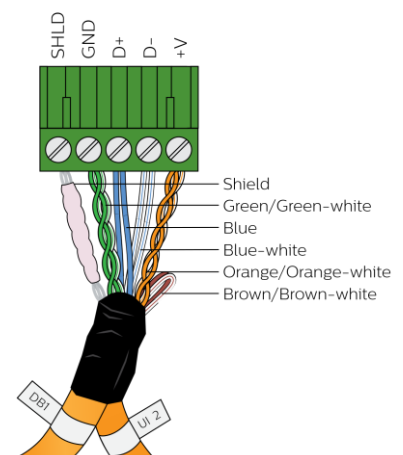

1.2 Standard RS-485 PIN outs

DyNet-F/UTP-CABLE-LSZH

Colour	Signal
Shield	Earth (cover with insulated sleeve)
Green/Green-White	Paralleled for Ground
Blue	Data +
Blue-White	Data -
Orange/Orange-White	Paralleled for +V (12/24 VDC)
Brown/Brown-White	Spare pair can potentially be used to replace a damaged pair.

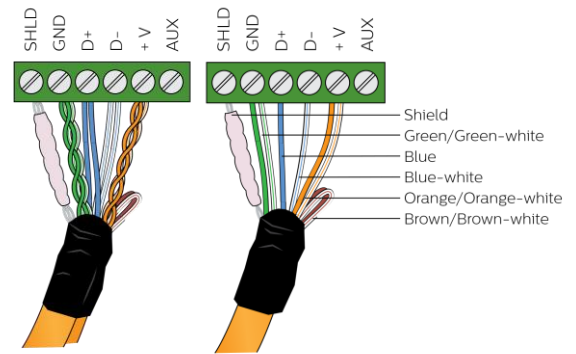

Daisy chained, first and last device

DyNet-SFLAT6-CABLE

RJ12 Pins	Colour	Signal
-		
1	Silver	Ground
2	White	Ground
3	Red	Data +
4	Green	Data -
5	Yellow	+V 12/24 VDC
6	Brown	+V 12/24 VDC
-		

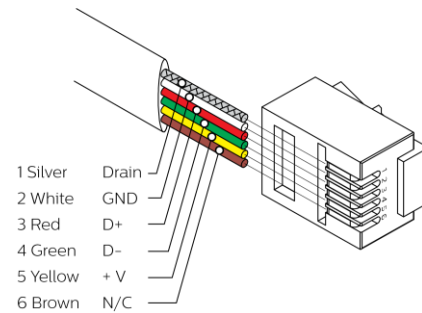

Cat 5e/6 Ethernet cable T568A

RJ12 Pins	Colour	Signal
1	Green-White	Data +
2	Green	Data -
3	Orange-White	Not connected
4	Blue	+V 12/24 VDC
5	Blue-White	+V 12/24 VDC
6	Orange	Not connected
7	Brown-White	Ground
8	Brown	Ground

*Pins 3 and 6 may be used for Shield connection.

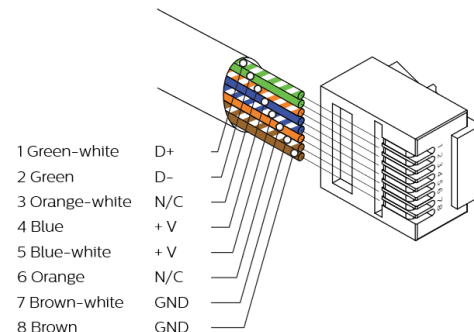

Cat 5e/6 Ethernet cable T568B

RJ12 Pins	Colour	Signal
1	Orange-White	Data +
2	Orange	Data -
3	Green-White	Not connected
4	Blue	+V 12/24 VDC
5	Blue-White	+V 12/24 VDC
6	Green	Not connected
7	Brown-White	Ground
8	Brown	Ground

*Pins 3 and 6 may be used for Shield connection.

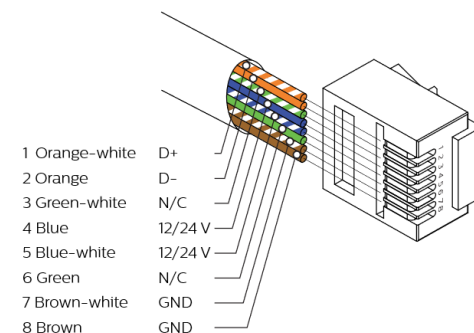

Dynalite pinout summary table

Terminal	DyNet Cat5e/6	T568B Spec RJ45	Belden 1502	RJ12
+V	Orange	Blue		
+V	Orange-White	Blue-White	Red	Yellow
D-	Blue-White	Orange	White	Green
D+	Blue	Orange-White	Blue	Red
GND	Green	Brown	Black	Black
GND	Green-White	Brown-White		
SHIELD	Drain Wire			

 T568A is not recommended

1.3 DMX wiring

There are three use-cases to be considered.

1. RS-485 wiring for DMX is mostly the same as for DyNet. This is true when we are controlling our Load Controllers via DMX as well as other DMX drivers.

In this case every corresponding DyNet termination (Shield, Gnd, D+, D- & +12v) on the DACM in DMX mode, will be wired the same on the Load Controllers.

2. With No load controllers, you will need to provide the DACM in DMX mode, with a power supply, and an Earth termination. Adding a DDNP1501 will solve both problems; 15 V Supply and Shield Terminal, so wiring again will be the same.
3. In the case where the power supply is provided by a third-party plug pack without an Earth terminal, then the Shield terminal on the DACM in DMX mode, must be connected to an Earth point (perhaps at the fixtures end).

 We do not recommend the use of third-party plug packs.

 For DMX transmission, the cable shielding should also be connected to Earth (in this case using the shield terminal, which must be Earthed at some point on the cable run).

1.4 Recommended control cable types

For serial port connections, the recommended cable is screened RS-485/Cat5e/6 data cable, such as DyNet-F/UTP-CABLE-LSZH.

Supplier	Cable
Dynalite	DyNet-F/UTP-CABLE-LSZH
Dynalite	DyNet -SFLAT6-CABLE. Limited to 9600 bps. Maximum length 100 m (330 ft).
Belden	1502R or 1502P (P = plenum)
Belden	9503
Garland	MCP3S

We recommend maximum 300 m segments @ 9600bps for a spur with mixed topology. For long lengths up to 800 m and on trunks with up to 115 kbps speed, 120 Ohm, 2 W terminating resistors must be added on both ends of the network (like in DMX512 case) and daisy chain is the only topology option.

Belden 1502 or equivalent, with low or no DC load on +V power wire, can achieve distances over 300 m (1000 ft). CAT5e/6 has higher resistance, so we recommend 300 m (1000 ft) for those with 0.2 mm² (24 AWG) wires as a conservative limit, provided GND and +V use a twisted pair in parallel as shown on drawings.

- Other F/UTP (Foil shielded) or STP (Shielded) CAT5/6 cable types may be used, provided their specifications meet or exceed Dynalite specifications and local wiring code requirements.
- Use of UTP (unshielded) CAT5/6 cables is not recommended, however, may perform acceptably for short runs of under 15 m (50 ft) where there is no risk of noise coupling.

Unshielded cables shall not be used in installations with capacitive sensing technology products (User Interfaces with DACM), otherwise correct operation may not be achieved. Unshielded cables must be installed in grounded metal conduits if there is a risk of noise coupling from Mains or UL Class 1 cables such as for switched power circuits, high-frequency power electronics devices, HVAC, and motor drives, etc.

If the installation conditions dictate use of UTP CAT5/6 cables (e.g., retrofit scenarios where existing cabling is reused), it may require Proximity Sensing feature to be disabled on related products, with the installer taking full responsibility for any related performance issues.

I.5 Devices on a single cable run

The Dynalite network uses a trunk and spur topology. Trunks can be RS-485 or Ethernet. Spurs are primarily RS-485 but can be over Ethernet for devices with Ethernet ports. Each spur is connected to a network gateway that connects to the trunk network. If required, an RS-485 spur can be separated into network segments with network isolator gateways (such as the DDNG485).

If >128 devices are needed on a spur, repeaters must be added (such as the DDNG485) to separate segments and refresh the signal levels (and filter traffic where needed). The maximum number of devices of the same type in a network segment is limited to 255.

Using multiple trunks and spurs with isolators and network repeaters, removes any realistic limitation on a single Dynalite network.

Maximum number of devices on a single network segment.

Cable Length	Belden 1502P, 1502R (18 AWG)	Cat5e STP, 8 x 0.2 mm ² (24 AWG)	Cat5e UTP, 8 x 0.2 mm ² (24 AWG)
< 15 m (50 ft)	128	128	64 (no capacitive sensing products)
75 m (250 ft)	128	100	-
150 m (500 ft)	128	75	-
300 m (1000 ft)	128	50	-

Devices come with three serial number/barcode labels:

- A label on the device
- A label for the plan (used for commissioning)
- A label for site documentation

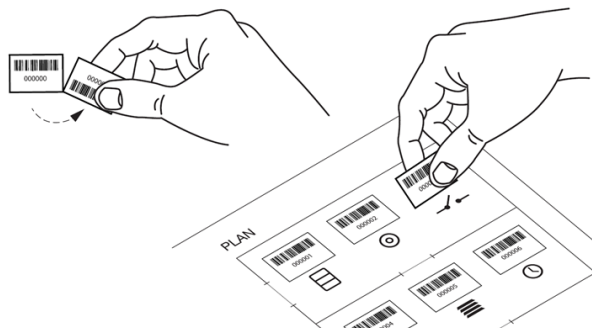

1.6 1-10V cabling

1-10V uses mains rated polarized cabling; typically, a single pair “figure-8” cable. Positive wire may have a dashed line.

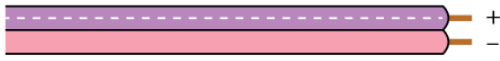

DDBC, DBC, DMB, DDMC, DMC controllers and DGBM, DMD modules provide 1-10 V control and automatically sink or source current depending on the connected lamp driver. The DDBC1200 controller can provide 0-10 V or 1-10 V dimming in sinking and sourcing mode.

Typical considerations when installing a 1-10 V circuit:

- Loads must not use a mixture of sinking and sourcing drivers.
- An analogue circuit can typically accommodate around 10 luminaires per controller. The maximum number of drivers allowed on an analogue output depends on controller specifications such as, box loading, channel loading and circuit characteristics. Check the controller/module specification sheet for detailed information.
- 0/1-10 V control signal is polarity sensitive. Positive and negative outputs from the controller must be connected to the corresponding positive and negative inputs on the driver. The circuit will not work if wires are reversed.
- If the control signal is not connected or a wire is broken, the driver shall go to the maximum value or the system failure level, if applicable, to keep the lights on.
- If 0/1-10 V wiring is run in parallel with AC wiring, for improved noise immunity, it is recommended to use shielded cabling with the shield grounded to Earth at the controller. Unshielded analog control wiring can act as antennae, which may be interpreted by the driver as changes in the control voltage resulting in a flicker effect.
- As 0/1-10 V is an analogue protocol, the signal can suffer from voltage drop over a long cable run >30 m (100 feet), directly impacting the light intensity. Therefore, stranded wire should be used with a cross-sectional area of at least 0.82 mm² (18 AWG) and the cable run should be less than [90 m] (300 feet).

1.7 DALI cabling

DALI uses mains rated non-polarized cabling; typically, a single pair 'figure-8' cable or more often combined with lighting gear supply cabling. DALI has free wiring topology (daisy-chain, star or combined) but ring-shaped connections should be avoided. No termination resistor is required.

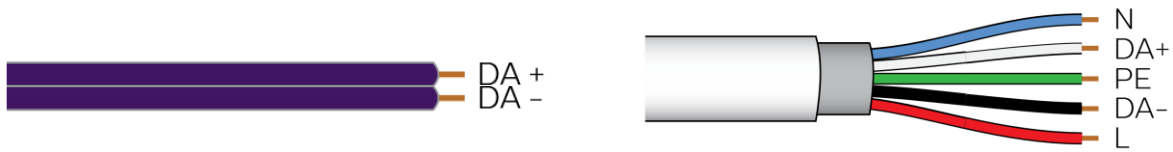

⚡ Safety warning: DALI is not touch-safe and shall be treated as FELV (functional isolation only, not Safety) per IEC Classification. DALI could be at a mains potential (LIVE), because only basic isolation is provided. The DALI control cable must be handled as any other LIVE mains cable, potentially up to 230 VAC. This must be considered when installing DALI devices such as DALI Sensors and Dry Contact Interfaces on the DALI bus.

DALI voltage range: 12–21 VDC, nominal 14–16 V. Maximum combined DALI Power Supply current rating (nominal and short circuit): 250 mA per Universe or Galaxy (output).

Maximum bus length from any point to the DALI controller should not exceed 300 m (1000 ft), to ensure signal integrity is not adversely impacted by cable inductance and capacitive loading (providing they are not dedicated comms cables with controlled impedance).

Smaller gauge wires are allowed providing the resistance limit of 4 Ohms (end-to-end wire loop resistance) is not exceeded.

Wire gauge	Maximum cable distance
0.5 mm ² (20 AWG)	Up to 100 m (330 ft)
0.75 mm ² (18 AWG)	Up to 150 m (500 ft)
1.5 mm ² (15 AWG)	Up to 300 m (1000 ft)

Dynalite DALI-2 controllers support DALI input devices. Device addresses are in addition to the lamp driver addresses. The total number of DALI devices and DALI drivers supported on a single output is shown in the following table.

	
10	64
11	59
12	54
13	49
14	44
15	39
16	34

1.7.1 DALI topology

DALI Broadcast

— DALI Cable — DyNet Cable

Each independent lighting group requires individual wiring.

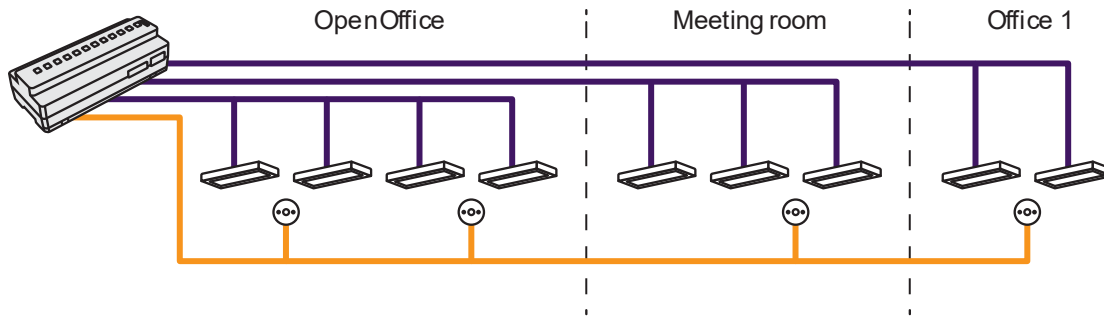

DALI Addressable

The same DALI bus wiring to DALI enumerated lamp drivers. A single universe has up to 64 driver addresses.

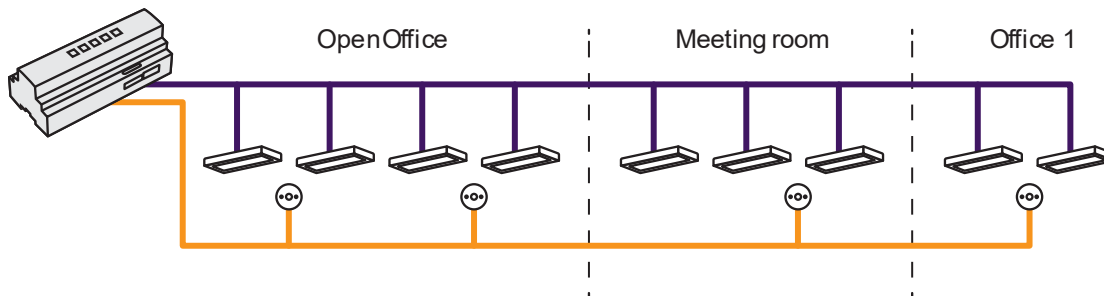

DALI with multi-master

The same DALI bus wiring to DALI enumerated lamp drivers and DALI multi-master devices such as sensors (e.g. DUS360CS-DALI) and dry contact input devices (e.g. DPMI940-DALI).

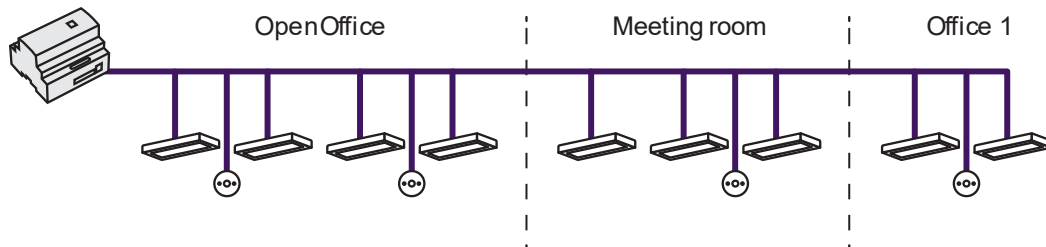

1.7.2 Scaling DALI networks

To extend DALI beyond the standard limits, a DyNet network with multiple DALI controllers is often used. This enables many DALI networks to operate together as part of the larger DyNet network and provides install lengths of > 800 m.

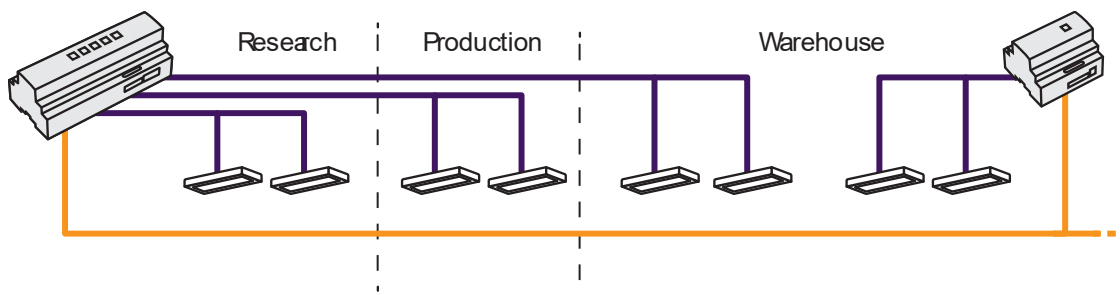

2 Installing load controllers

1. When deciding on the mounting position, controllers must be mounted in a dry, well-ventilated location. Observe recommended spacing around controllers and consider that controllers may emit some mechanical noise.
2. DIN rail controllers must be mounted horizontally (unless otherwise stated in the design) in a Standard Electrical Enclosure.
3. Wall mounted controllers must be mounted vertically (unless otherwise stated in the design) following ventilation guidelines.
4. The standard terminal layout of all Dyalite DIN-rail controllers has all mains power cabling terminating at the top and extra low voltage cables (control network, dry contact inputs etc.) terminating at the bottom of the controller, provided natural high/low voltage segregation.
5. Ensure suitable circuit overload and safety protection is installed and labelled.
6. Power and data wires should be segregated as per standard practice. Terminate according to the installation instructions in compliance with the applicable Electrical Code.
7. Mains supply must be connected to Protective Earth, Neutral and Line terminals on each controller.
8. Mains controlled loads must be correctly installed and connected to the load controller output terminals.
9. Individual and total channel loading must be within the specified ratings limits for each type of load. LED derating for Trailing edge is ~50% and for Leading Edge is ~30%.
10. PWM controllers require a suitable DC power supply. All other load controllers are connected to mains supply.
11. Auxiliary/UL924 input is a programmable dry contact interface that is active low. A dry contact input is connected between the AUX/UL924 and GND terminals on the DyNet connector strip. Ensure that the cable length between the dry contact and terminal strip is no longer than 20 m (65 ft). DyNet and Dry contact wiring must meet SELV installation and insulation requirements as per applicable Electrical Code.
12. DALI Controllers:
 - a. If DALI is not included with mains cable, or bundled with fixture, then run a two core DALI bus cable to the fixtures. This cable is in addition to the mains feed.
 - b. DALI must have no more than 64 drivers per universe.
(Recommend approximately 50 drivers per universe to allow for expansion).
 - c. The DDBC320-DALI and DDBC120-DALI supports a limited number of Dyalite DALI user interface/sensor devices on each universe. For more information, refer to the DALI Multimaster device and driver table (on previous page), and specification sheets.
 - d. DALI Controllers have an inbuilt DALI power supply. No external additional third-party DALI power supplies are allowed to be connected.
 - e. Where an inbuilt relay is provided in the controller, power for all drivers on a DALI line must come via the matching inbuilt power relay. For example, connect CH1 OUT to all drivers connected to DALI 1.

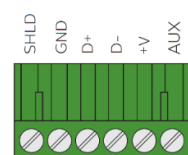

DyNet RS-485 Serial Connector with Auxiliary terminal

Installation example

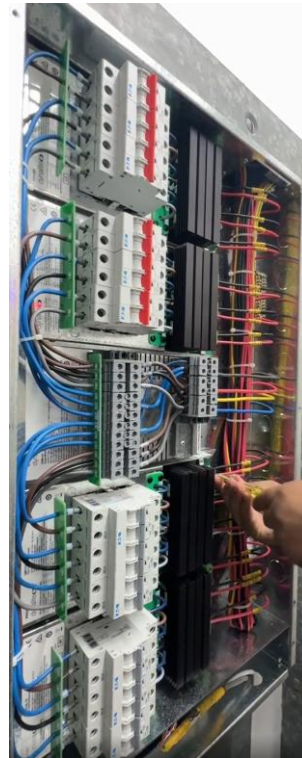

DIN rail mounted controllers



Wall mounted controllers



Safety warning: The control equipment is connected to potentially lethal power supplies. To ensure safety during system maintenance, Installers must always follow safety installation rules and isolation procedures as per the applicable electrical code.

2.1 Circuit breakers

MCBs (Miniature Circuit Breakers) or standard circuit breakers protect against fault current. They are thermal magnetic, meaning if they get hot due to overload, they will trip. They will also trip based on an inrush of current causing a large magnetic field.

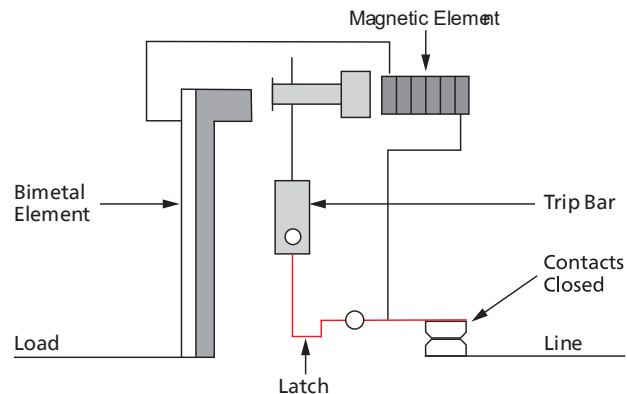

Trip curve type	Trip curve range	Typical usage
Z	2 to 3 x rated current	Sensitive equipment requiring a very fast trip response.
B	3 to 5 x rated current	Residential applications with low-surge resistive loads such as appliances and lighting.
C	5 to 10 x rated current	Commercial applications, such as transformers, motors and fluorescent lighting.
D	10 to 20 x rated current	Used for large motors and certain lighting loads with high inrush currents.
K	10 to 12 x rated current	Heavy inductive loads used in industrial applications.

Understanding how Residual Current Device's (RCD) function.

Kirchhoff's 1st current law states that current flowing into a junction is equal to the current leaving the junction.

This is the exact principle of an RCD. The current flowing through the active must be equal to the current in the neutral. If the current is not equal or out of balance, then it is being 'lost', typically to Earth.

RCD's work using a magnetic amplifier with a toroidal common mode choke. In the diagram below, any current flowing through the active (L) is canceled out by the returning neutral (N).

However, if some of the current flows to Earth then the toroidal common mode choke now induces a voltage into the trip coil of the RCD and activates the trip mechanism. The test button is on the secondary side of the toroid and connected to neutral via a resistor (~1M ohm) and causes an out of balance current, again causing the trip coil to energize and trip the mechanism.

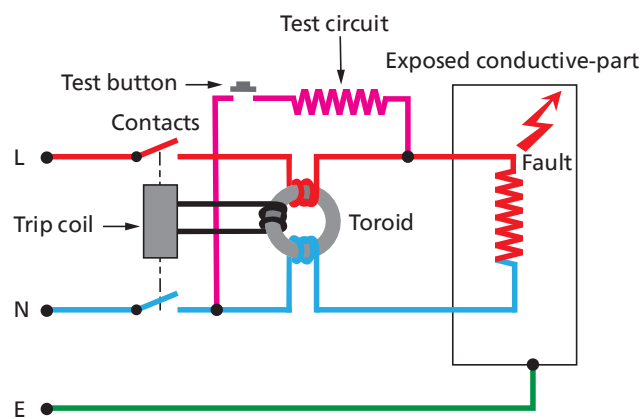

RCBO

RCBO's are a combination of a standard thermal magnetic breaker and RCD.

Considerations:

- RCD and RCBO are guaranteed by the manufacturer to operate at their designed trip current, typically 30 mA.
- Hospitals typically have 5 mA protection for GPO's next to patients. This is not to say they may operate early, remembering it is a magnetic amplifier and discrepancies in the toroid or windings may affect its trip current.
- The rating of the RCD is for the total connected load i.e. everything downstream of the RCD. For example. 30 mA
- The rating of the RCBO is also for the total connected load such as, for example, 20 A/30 mA.

Applications

Some devices have filters or capacitors which discharge a small amount of 'noise' or ripple on the line to Earth to improve supply to the device, and this is an acceptable practice. However, you do need to be aware and calculate for it. Australian Standard AS3000 also notes that the loading of the circuit should be such that the leakage current does not exceed one-third of the rated residual current.

What does this mean for lighting controls?

- **Leading/Trailing Edge**

Let's look at the example of a DMC2 with a DMP310GL module, 3-channel x 10 A dimmer.

If you place a 32 A per phase 30 mA RCBO to the supply of the dimmer you are certainly protecting all outgoing circuits however a single fault will trip the 3-phase supply effectively or potentially sending a large area into blackness. It also means that the total Earth leakage is limited to a maximum of 30 mA.

A better option is to go for a DMC2 with a DMP310GL-RCBO-CE module with individual RCBOs per output and a standard thermal magnetic 32 A 3-phase circuit breaker to protect the device.

In this scenario a single failure on circuit will result in only a single circuit being isolated while the remaining circuits continue to operate normally. It also means you have 30mA per channel.

The standard thermal magnetic 3-phase 32 A circuit breaker is there to protect the device against overload.

- **Power management for a DALI installation**

In a DALI installation you can have up to 64 DALI drivers/devices connected to the DALI controller, but the problem is how to best manage the power requirements, especially if you are using the onboard relays on a DDBC120-DALI or DDBC320-DALI. We will look at the single-relay DDBC120-DALI for this example, but it is the same principle for the three-relay DDBC320-DALI.

For this example, we will assume ~0.5mA of earth leakage per driver. 64 drivers x 0.5mA = 32mA of Earth leakage. This is problematic as it would trip the RCBO.

We would recommend the use of a 3-pole contactor dividing the total number of fixtures across three separate RCBO's with approximately 21 fixtures per RCBO ($21 \times 0.5 \text{ mA} = 11 \text{ mA}$). This mitigates a nuisance trip disconnecting all 64 drivers/devices. Typically, each RCBO would be connected to every third fixture.

The onboard relay of the DDBC120-DALI would be used to control the contactor coil. If more circuits are required, due to the connected load, more contactors can be cascaded off the DDBC120-DALI relay.

In the System Builder software, DDBC120-DALI and DDBC320-DALI have a setting to invert the operation of the on-board relay functionality, so if you are using normally closed (N/C) contactors, you can change the behavior to suit. This has the potential advantage of having the contactors fail to ON, if the supply to the DALI controller is lost.

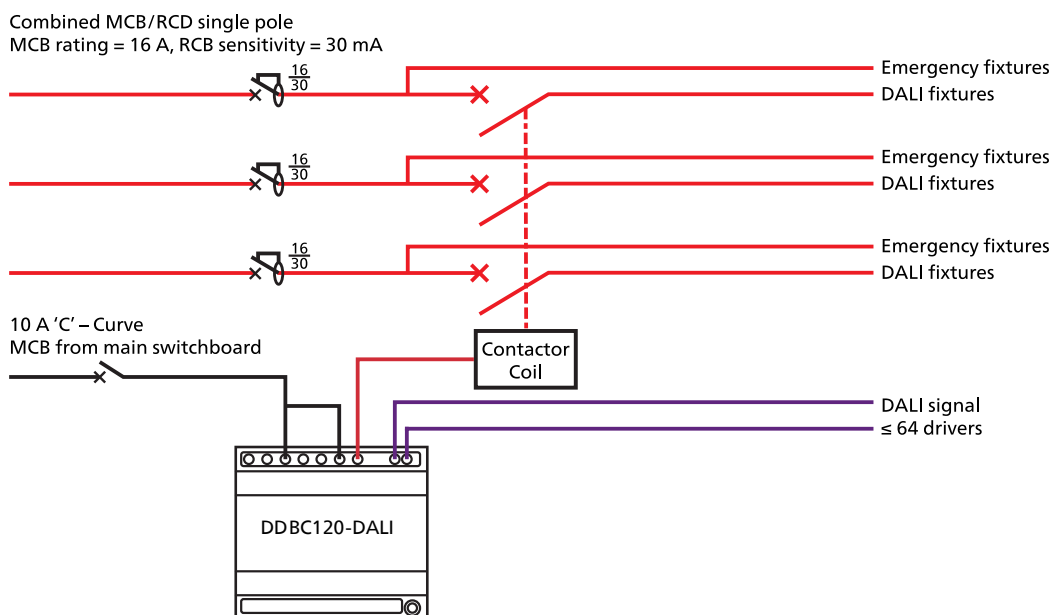

3 Installing gateways

In multi-story buildings, each floor typically contains an independent network segment called a spur. Spurs can be joined via network gateways to an RS-485 or Ethernet trunk network installed in a riser linking all floors together. The trunk typically connects to the System Manager head-end software enabling full access to the entire system.

 All circuits and cables connected to gateways must be SELV/Class 2 (UL).

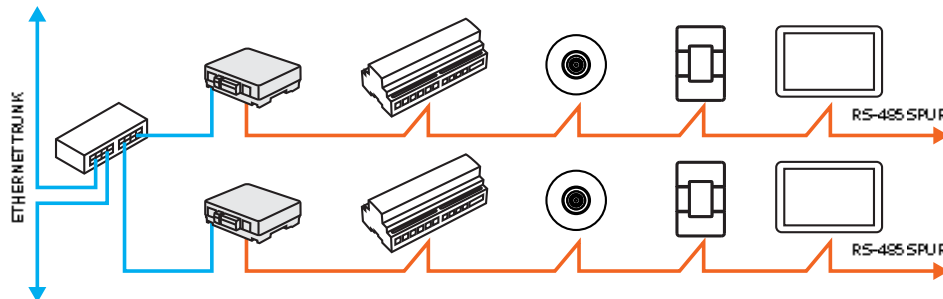

Ethernet trunk network and RS-485 spur network

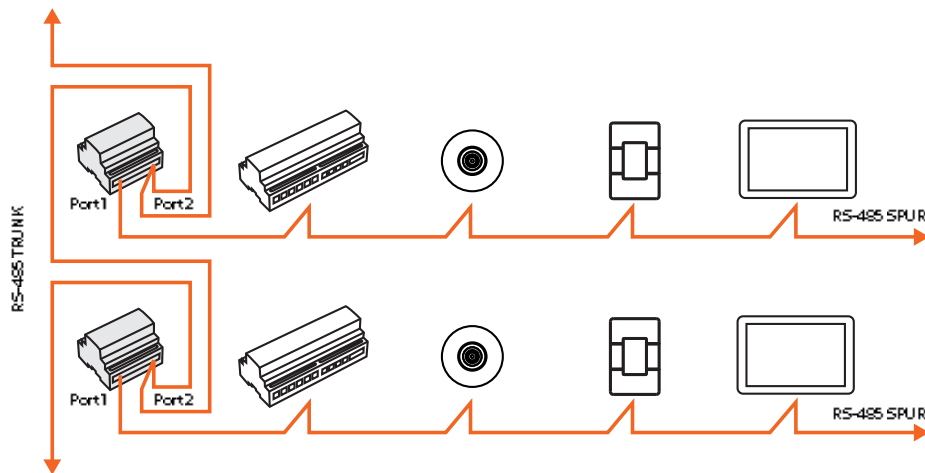

RS-485 trunk network and RS-485 spur network

1. For RS-485 networks, terminate both trunk and spur connections to gateway.
 - a. Spur (Floor sub-network) is terminated to Port 1.
 - b. Trunk (Building backbone) is terminated to Port 2.
2. An RS-485 gateway is powered from the DyNet network spur connected to Port 1. Up to 150mA of power from the DyNet network on Port 1 is fed to Port 2, so providing there is sufficient power available on the spur, it is not necessary to provide a network power supply for the trunk network.
3. When implementing repeaters for long runs, connect the link to Port 2 of both bridges. Shielded cable must be used for long runs (refer to Recommended cable types). Provide additional DyNet power supplies where required and ensure end-of-line resistors are in place.
4. DDNG485 bridges are required when more than 100 devices are required on a run, or the current may exceed the cable limit of 2 Amps.
5. DDNG485 Port 2 is used for DMX Receive/Transmit or for third-party integration.

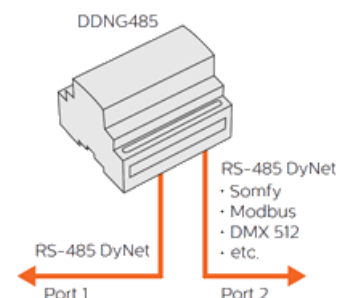

4 Installing user interfaces

Antumbra and Revolution keypads have two parts, a Communication module, and an Application module.

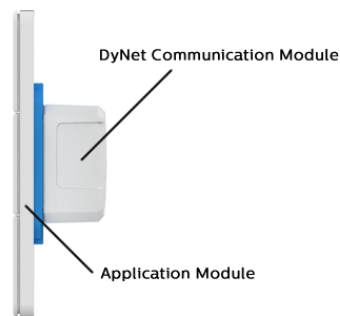

1. Follow device Installation Instructions to select an appropriate physical placement for the user interface.
2. Take care not to damage the wall surface surrounding user interfaces particularly when they have the light wash feature (PDTs, PAXBP, PADP and PATP).
3. All devices must be level and consistently surface mounted on the wall (vertically or horizontally) using the screws provided. A wall box may be required to comply with local electrical standards.
The mounting plate must sit flat onto the wall surface.
4. Wall box screw holes must be horizontal when mounting Revolution user interfaces.
5. Where buttons are engraved, check all labels are in the correct position before clipping into position.
6. Do not remove buttons from their protective/alignment sheet until the project is handed over.
7. User Interfaces should have 30 cm (12 in) clearance from any metal objects or nearby cables. Unearthed nearby metal objects such as stud work and door frames, may lead to false triggering of the lightwash effect. Ensure wall box and mounting plate are earthed according to the supplied installation instructions.
8. The metal mounting plate has an attached green Earth wire that must be connected to the DyNet shield terminal to protect the proximity sensor from false triggering.
9. For all user interfaces, the cable should exit towards the bottom to avoid moisture ingress.
10. If mounting a touchscreen in portrait mode, the Ethernet port must face downwards.
11. The PDTs touch screen requires a 10–30 VDC 900 mA external power supply.



Revolution



Antumbra



Touchscreen

4.1 Environmental sensor positioning

Revolution, Antumbra and PDTs have inbuilt environmental sensors. The sensors detect temperature and humidity (Antumbra only supports temperature) via the holes in one corner of the rim. The rim has built-in ventilation to increase the sensor responsiveness. However, the sensor holes require unimpeded airflow to accurately detect the current temperature and humidity in the room.



DO:

1. Install on an interior wall as it is less impacted by outside temperature fluctuations and will give a better indication of average temperature.
2. Install sensors in a frequently used room (primary location for comfort control)
3. Ensure there is free air flow around the user interface.
4. Install with at least 8 cm (3.15 in) clearance around the user interface.
5. Install the user interface 1.2 – 1.5 m above the floor.
6. Ensure that the rim holes are positioned over the temperature sensor when attaching the rim to avoid damage.
7. Position user interface sensor holes at the bottom of the device. (Application modules have arrows to show upward device orientation).

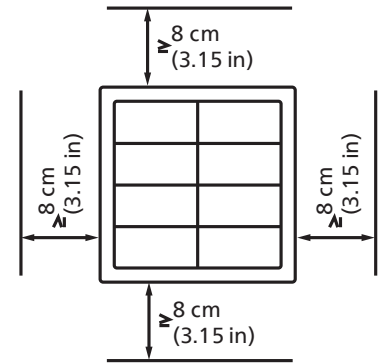

DO NOT:

1. Block airflow to the sensor holes.
2. Recess mount inside a wall or cavity.
3. Install in an enclosure or add another frame around the user interface.
4. Install near or above sources of heat.
5. Install where it will be in direct sunlight.
6. Install in a corridor with no direct air supply.
7. Install near windows or door frames.
8. Install near drafts or air vents.

Apartment floor plan example

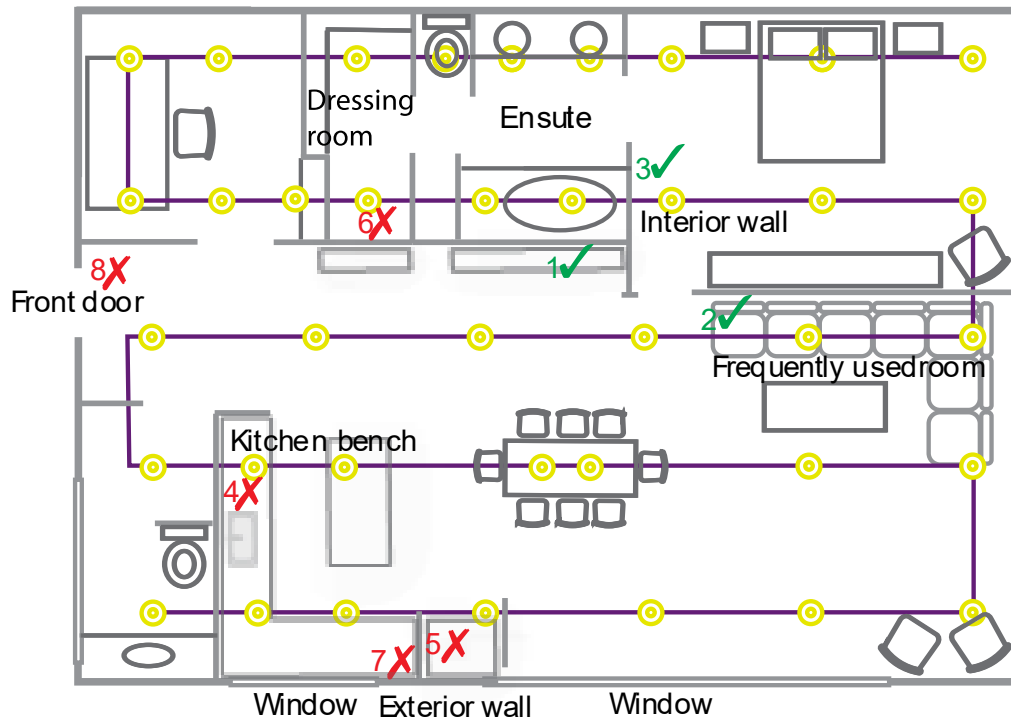

- * If a temperature sensor is affected by adverse conditions at a certain time of day and the room is controlled by a DDRC-GRMS-E, then the Multi-Temperature Aggregation feature can re-weight or disregard sensor readings when calculating the average room temperature.

5 Installing sensors

5.1 Motion detection positioning

A single Dynalite sensor can perform motion detection, light regulation and IR receive simultaneously.

Typical detection range is measured at $\leq 25^{\circ}\text{C}$ (77°F).

Range is reduced at ambient temperatures above 32°C (90°F)

Sensors must receive specified supply voltage 15 V or 24 V \pm 10% from the DyNet network. If necessary, add a network power supply to ensure adequate network voltages are maintained during day-to-day fluctuations. Ensure the 2 A limit is not exceeded on any data cabling.

Position sensor to detect motion in a specified area:

1. Install correct sensor type PE, PIR, Ultrasonic, High-bay, Outdoor etc. for the location and application (wall or ceiling mounted).
2. Ensure correct orientation for long and short field of view.
3. Lift inbuilt mask where applicable, to limit sensor detection area.
4. Install sensor out of direct sunlight.
5. Install sensors away from air conditioning vents and sources of electromagnetic interference.
6. Except for ultrasonic detection, avoid obstructions when installing sensors.
7. Ultrasonic sensors are susceptible to interference and must be a minimum of 2 meters away from noise and vibration sources. Two ultrasonic sensors must be at least 18 meters apart to avoid interfering with each other.

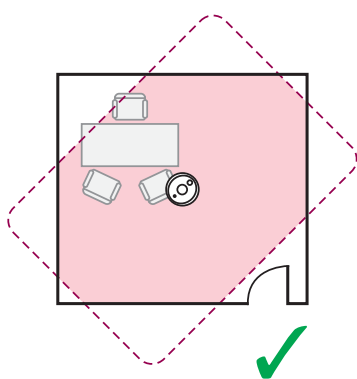

Lights trigger only upon entry passersby

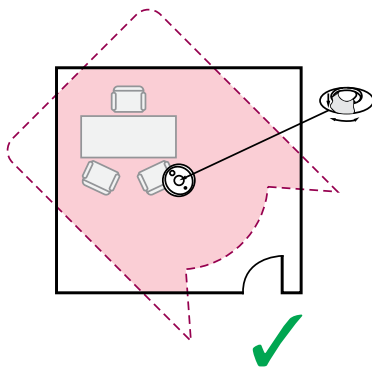

Using detection area mask

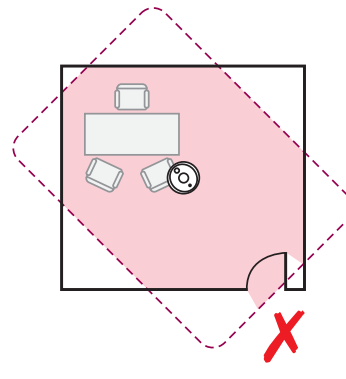

May trigger from

For detailed information, refer to the Dynalite Networked Sensor Positioning Guide (www.dynalite.com).

5.2 Light regulation positioning

When positioning sensors, there are two methods of light regulation to consider (speak to design engineer if unsure):

- If the sensor is used for Closed loop sensing, then position the sensor so it sees a mixture of indoor and outdoor light.
- If the sensor is used for Open loop sensing, then position the sensor so it sees the light level from one light source such as daylight, to adjust light levels elsewhere.

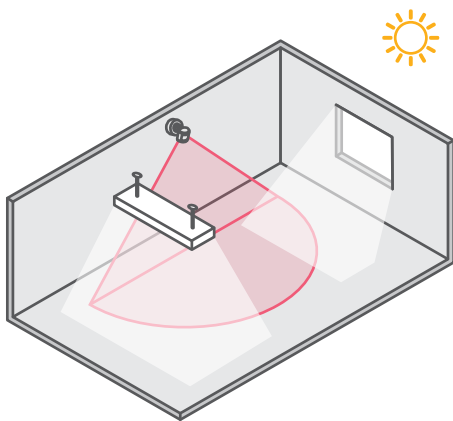

Closed loop light regulation

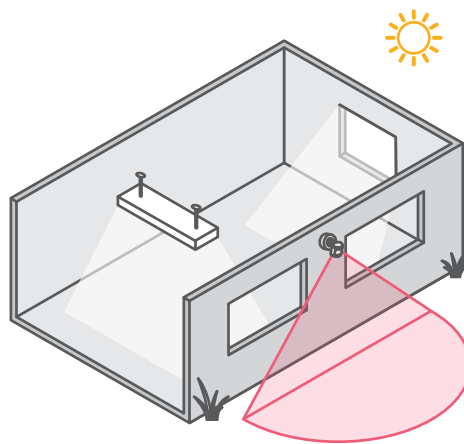

Open loop light regulation

5.3 Inbuilt indicator LED

When first connected and powered from the network the red indicator LED on the sensor will flash for 3 minutes when it receives a button message. This allows the installer to confirm that the sensor is terminated correctly and communicates with other networked devices.

Indicator LED:

Red = PIR motion detection (All sensors).

Green = Ultrasonic motion detection (DUS804CS-UP).

Blue = Low network voltage (DUS804CS-UP)

6 Installing dry contact input devices

6.1 DLLI8I8O and DPMI940-DALI

1. Install as close to the switching source as possible. This also applies to AUX/UL924 inputs on controllers. Refer to the Installation Instructions for allowed cable lengths.
2. DLLI8I8O has an RS-485 interface and can be connected to eight open/close contacts and eight indicator LEDs.
3. DPMI940-DALI has a DALI interface and can be connected to four open/close contacts (must be used with a DDBC120-DALI controller).



DLLI8I8O



DPMI940-DALI

- ⚡ Safety Note:** DALI Dry Contact inputs are FELV (not touch safe) and are galvanically connected to the DALI network. ONLY Dry Contact switches with mains rated safety isolation shall be interfaced. Refer to device installation instructions for cable length, insulation requirements, and limitations.

6.2 DDMIDC8

1. Recommended for locations with potential EMF noise, long cable runs up to 50 m (165 ft), where additional optical isolation for dry contacts is required or for analog control integration.
2. Can be installed without a DIN rail by extending DIN rail clips to expose mounting screw holes.
3. If used, connect voltage-free contacts or 0-24V AC/DC inputs to any of the eight opto-isolated inputs. Remove the cover and ensure that the internal jumpers for each input are set to the appropriate 0-24V or voltage-free setting, according to the input type.
4. Setting the internal jumper to the volt-free position increases the current consumption of the device from 15mA to 40mA. This must be considered when selecting DyNet data cable and supply capacity.
5. If used, connect 0-5 V or 0-10 V inputs to the analog ports. Ensure the input is a maximum of 10 VDC. Faders can be directly connected to the analog inputs by using the adjacent +5V terminal as a supply. Suggested fader value is 10K ohm.
6. Only draw a maximum of 25mA from the +5V terminal.

- ⚡ Safety Note:** Analog input circuits must be SELV/Class 2 (UL).



DDMIDC8

7 Energising the System

7.1 Power-up tests

1. Once the network is connected and energised, a button press on any panel, controls all the dimmers (refer to Preset table). An unresponsive light indicates that the driver or lamp is faulty or incorrectly wired.
2. Go to the last panel in the run according to the wiring diagram and push buttons 1 and 4 (on and off) to confirm the integrity of the wiring all the way back to the distribution board. Lights should respond within 2 seconds and relays should turn off when all lights are set to 0%. Sensors will flash for 3 minutes.
3. On each panel, push the buttons to confirm that the panel is working. The indicator LED should illuminate on the pushed button. Buttons on other panels should match to track the button pushes (note: dry contact UIs may not have indicators fitted).
4. If a button LED indicator does not light, remove the panel and check the wiring and network voltage. Repair network wiring as necessary (refer to the troubleshooting section).
5. For touchscreens, use the Preset buttons or sliders on the page to dim channels and confirm that the touchscreen is communicating with the network.
6. All devices are pre-programmed for out-of-the-box operation. Dynalite load controllers (dimmers) are set to provide full output by default, irrespective of having the network connected.
7. Where provided, use the manual override switches to test output circuits and loads. Ensure the correct circuits switch accordingly. Be aware that relay controller outputs configured for double-throw operation (blind/curtain control), will respond differently when using override switches.
8. To turn the lights onto full, push the service switch on the load controller three times in succession.
9. To run the DALI flash sequence, push the service switch on the DALI controller four times in succession. Drivers will flash the lights for 5 minutes, then return to their original state. Hold down the service switch for 5 seconds to reset the controller and stop the flash sequence.



Danger: The manual override buttons/switches on the controllers do not provide permanent isolation. Controllers may be fed from multiple circuits. To isolate the controller outputs, power must be disconnected at the circuit breakers feeding mains to the controller and to any pass-through circuits.

7.2 Default Preset Scenes

The factory default presets for User Interface panels are listed below. Note that some panel types hide or occupy more than one button position.

Button	Preset	Light level	Button	Preset	Light level
1	Preset 1	100% (ON)	5	Preset 5	80%
2	Preset 2	70%	6	Preset 6	60%
3	Preset 3	40%	7	Preset 7	50%
4	Preset 4	0% (OFF)	8	Preset 8	20%

7.3 Controller Service Switch

The relevant Service Switch functions are:

- **3 pushes** – All Channels 100%. You should do this to normalize the connected driver settings. (DALI Broadcast Channels will setup the connected drivers with Min/Max/PowerOn/SystemFail levels, and 2 second Fade Time).
- **4 pushes** – A DALI enumerated controller will go into test mode and run a flash sequence for 5 minutes.
- **Push and hold for 5 seconds and release** – Device reset

7.4 Controller Service LED

The Service LED has four signalling modes:

- **Blinking slowly (0.5Hz)** – Normal operation.
- **Blinking normally (1Hz)** – Network activity detected or DMX reception.
- **Blinking fast (4Hz)** – Device communicating.
- **Permanently ON or OFF** – Fault.



Some devices support a bicolour service LED. The same blinking pattern is valid for both Red and Green LEDs. Red is the standard colour for all devices. Green shows reception of DyNet heartbeat from another DyNet device, such as a Gateway.



8 Fault finding

8.1 DyNet bus issues

After completing the power up tests, all controllers should react to a single button push. If not, check for any discrepancies between the installation and the installation instructions and check troubleshooting symptoms. To rectify problems, follow these five steps:

1. Analyse the symptoms.
2. Diagnose the cause.
3. Repair the problem.
4. Verify the solution.
5. Prevent the issue occurring again.

8.2 Electrical measurements

If faults are occurring, one of the first things to check is the typical RS-485 DyNet voltages. Incorrect voltages may indicate short/open/crossed circuit or the need for an additional power supply.



Important: Mains fed load controllers and power supplies contribute power to the network. Gateways, button panels, dry contacts and sensors consume power from the network.

Electrical Property	Values
Correct minimum – maximum network supply voltages:	European (EU): 12 to 18 V (nominal 15 VDC) between Gnd and +V terminals North American (NA): 20 V to 26 V (nominal 24 VDC) between Gnd and +V terminals
Typical data voltages with reference to ground (Gnd):	D- between 0.2 VDC to 1.0 VDC D+ between 0.5 VDC to 3.8 VDC D- to D+ must be greater than 300 mV during transmission
Maximum DyNet network supply/load current	2 Amps

8.3 Unresponsive devices

If the controls are not responding as expected, follow the procedure below to isolate the fault. To fault find on a large network, start small, working from the devices on the spur and eventually moving to the trunk. If you are still unable to rectify the fault, make a list of devices used in the system and contact technical support, via the Signify Partner Portal.

Isolate a fault in the network:

1. Find the midway point of the spur.
2. Break the network into two halves at a field device (user interface or sensor) and power both halves.
3. Perform power-up tests (refer to: Energising the system) in each half of the network; this will identify which half has the problem.
4. Continue to break the half into quarters etc. Repeat power-up tests until you find the fault.





For suspected broken wires, you can substitute the spare brown/brown-white pair to see if it fixes the problem.

8.4 DALI Bus Issues

Tools:

- Digital Oscilloscope 10 MHz bandwidth or greater
- Safety Isolated Differential Probes 1 MHz bandwidth or greater

 **Safety Notice:** DALI wiring is not touch safe. Before taking measurements ensure devices are properly installed with appropriate Earthing. If unsure do not perform test and seek advice from qualified personnel.

 **Important:** Standard Digital Oscilloscope probes must not be used.



Using a digital multimeter, check presence of DALI power and confirm wiring continuity and no short circuits. Measurements are taken across DA terminals on a DALI device. Expected a reading in idling state of 12–21 VDC.

If the reading in idling state is between 2–12V, potential causes could be:

- Overload (too much DALI bus load)
- Faulty device online.

If the reading is < 2 V, there is potential wiring fault on the DALI line.

When the built-in test sequence is initiated, an occasional repetitive voltage dip is noticeable on multimeter because of data packets creating short supply interruptions. This is a normal indication of dataflow.

If potential mis-wiring or short circuit is suspected on an output or between two different outputs, a way to test with the multimeter, is to connect one DALI Bus at a time to the controller & power supply side and check bus voltage on all DALI circuits: if any of the disconnected and unpowered DALI circuits is still returning a 12–21 VDC reading there is likely a 'cross short'.

8.5 Advanced DALI Bus issues

Measurements are taken between DALI wires. This method is the most comprehensive and can uncover issues which other 'static' methods (like digital multimeter test) cannot.

Overall signal edges shall show a clear and sharp rise/fall time.

Idling at 16 V must be within 12–21 V
(1:20 probe used)

The time between a rising and falling edge is 416 μ S apart which equates to 2400 baud.

Signal low level must be < 4 V. It can vary depending on type of DALI device, physical position on network, distance from power supply etc.

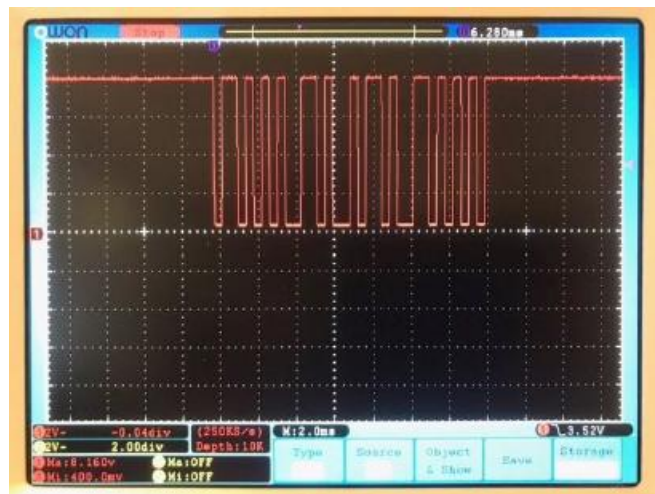

9 Fault finding with System Builder

More advanced diagnosis can be performed with System Builder. System Builder can help you to identify if the cause of the issue is hardware, device configuration, network or software.

9.1 Trunk and Spur Messaging

Running two System Builder instances can help identify issues with the network or device configurations.

- Connect first System Builder instance via a PC Node to the RS-485 spur.
Make sure you can sign on all the devices on your network before moving on.
 - Connect second System Builder instance via a PDEG to the Ethernet trunk.
OR
 - Connect second System Builder instance via a PC Node to the RS-485 trunk.
- ☰ For RS-485 connections, daisy chain is the only topology option. This is to stop signal reflections in the data cable. Refer to Introduction point 8, for more information.
- ☰ Typically, the RS-485 Trunk Baud rate would be set higher than the default of 9600 to 57600. When connecting your PC to the trunk, to see the trunk messages, ensure that you configure the System Builder serial connection at the same higher baud rate.

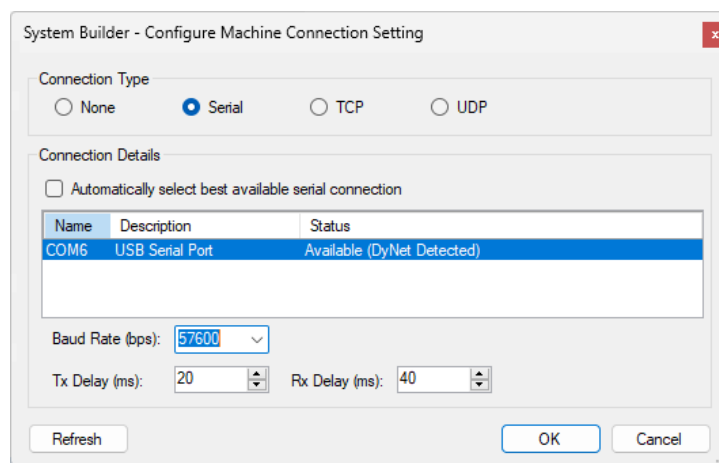

9.2 PDEG and PDDEG-S Logs

Gateways store network messages for 28 days. The log files can be very useful when looking for erroneous behaviour on a site. To view gateway log files, right click a PDEG/PDDEG-S and select  Manage Log Files.

If the client can provide the date and approximate time of incorrect behaviour, you can view the log files in System Builder to help identify unexpected messages such as bad packets, reboot messages or preset messages outside of the expected address range.

- ✳ Refer to the System Builder Quick Start Guide for more information about using the Network Log.

9.3 Legacy Devices

From System Builder, select  Insert Devices from Network (Ctrl+L), and from the Search Devices tab, select the Include Legacy checkbox before starting a device search.

Some older projects may have some early devices that are not supported by System Builder. They may sign on but will not load.

9.4 Virtual Machine

Having a VM installed on your machine with a basic Windows XP (32 bit) shell and DLight2 (Installer Build 985 and Update Build 985) installed is also a very useful tool in case you come across an older product that is working but may require some configuration changes.

9.5 Unique Fade Times

Using a unique fade time (for example a 3-second fade time), can help identify the source of an unexpected message

This can also be useful when triggering tasks, so you can identify that a task has been triggered.

DyNet(0x1C,0x15,0x64,0x00,0x00,0x00,0xFF)

where 0x64 = 2 Seconds and can be changed to 0x96 = 3 seconds.

ID ^	Local Time	Relative Time	Data	Description
2	08:43:05.925	00:00:00.000	1C 15 64 00 00 00 FF 6C	Area 21 Recall Preset 1 with a fade of 2.00s
1	08:37:14.049	00:00:00.000	1C 15 96 00 00 00 FF 3A	Area 21 Recall Preset 1 with a fade of 3.00s

9.6 Debugging messages

A debugging message can be useful and help identify where you are within a task. If there is a problem, then you can see when the last debug message was successful and the task stopped due to an error.

DyNet(0x6c,"GoToOn") //Debug – Can only be 6 characters long

Recommend using DyNet(0x6c,"GoTo01"), DyNet(0x6c,"GoTo02"),

DyNet(0x6c,"GoTo30"), to see exactly where the tasking gets to, to help identify a coding error.

UIText(TextMessage="really long debug message")

9.7 DALI Diagnostics

If you have a System Builder Technician license, then you have access to the DDBC320-DALI DALI Diagnostics editor. Click  Query DALI Network Status to automatically detect faults on the three connected DALI networks.

For more information, refer to the online System Builder User Guide > Signal Dimmers > Property Editors > DALI Diagnostics.



If you have completed the Dynalite Foundation training and passed the quiz then you can apply for a System Builder Technician License.

10 Troubleshooting tables

10.1 Load Controller Issues

Symptom	Probable cause	Solution
Controller does not operate at all. No Service LED activity.	Faulty mains supply connection. No power available. Controller is damaged.	Check power supply connections to the device. Check Fuse if fitted. Replace controller or modules if faulty.
Service LED not lit.	Supply voltage too low. Short circuit on network wiring. Faulty controller.	Check supply voltage. Check for correct DyNet voltages at each device. Isolate and energize to determine if the fault is external to the controller. Replace controller or modules if faulty.
Device appears to be operating but all channels stay at full output.	Incorrect wiring on DyNet port. Panic/UL294 function activated. Check Manual override switches.	Check DyNet port wiring, verify button panel is operating correctly. Check if emergency state has been activated. Disable or isolate DMX.
Device operates properly but circuit breakers/RCD/RCBO continually trip.	Earth leakage is exceeded or short circuit on load. Device overloaded. Incompatible load.	Check load wiring for short circuits. Verify device loading with current tester (remember to de-rate for specific loads and install conditions). Check total earth leakage. Check wiring terminals are tight. Perform a full power cycle to clear fault condition.
Dimmable lights won't dim or continuously flash.	Wrong type of driver or driver incorrectly wired. Wrong lamp type. Missing or mis-wired dimming bus cable. Device may be in test mode	Check that bus cable is connected to drivers. Inspect the driver to confirm the driver type. Check cable polarity if using 1-10V control. Check wiring against the driver manufacturer's diagram. Check if the driver is DALI certified. Check for correct DALI bus voltage: 12-21 VDC.
Can't control lights that were previously working.	Integrated third party system may require configuration. Fault on RS-485 DyNet bus	Disconnect third party equipment to isolate the system and identify the cause. Perform standard fault-finding tasks

10.2 User Interface, Sensor and Dry Contact issues

Symptom	Probable cause	Solution
Device does not operate or indicator/display flashes.	<p>Wiring issue on DyNet bus.</p> <p>No or insufficient power available.</p> <p>Low voltage</p>	<p>Check power supply to the device.</p> <p>Check for broken wires.</p> <p>Check controllers are online and contributing to the network supply.</p> <p>Add power supply to boost voltage.</p>
Light Wash effect false triggers	<p>Unearthed metal objects within 30cm (12 in) of panel.</p> <p>Wall box and mounting plate earthing not applied as per installation instructions.</p> <p>Strong electrical noise from nearby VRV Air Conditioner / Motor Drives, AV equipment or a non-compliant Light Source / Appliance</p>	<p>Ensure that all metal in the wall and surrounding metal is Earthed.</p> <p>Connect the DyNet shield, wall box and mounting plate to Earth.</p> <p>Ensure that unused wires have been connected correctly to Earthed shield terminal (for example Brown/Brown-white pair).</p> <p>De-energize potential noise sources in a sequence and run a test to localize problem. Further segregate cabling where required and separate Earth return to minimize noise contamination on network. Isolate and replace any non-compliant equipment found.</p>

10.3 Touchscreen issues

Symptom	Probable cause	Solution
Device does not operate at all	<p>No power available.</p> <p>Wiring issue.</p>	<p>Check power supply adaptor and ensure correct supply voltage and current.</p> <p>Check for shorted or broken wires.</p>
Device is on but not able to control anything	<p>Broken power supply wire.</p> <p>Broken wire on RS-485 bus.</p>	<p>Check plug is inserted correctly.</p> <p>Check for shorted or broken RS-485 wires.</p> <p>Check voltage at device for correct electrical values.</p>
Light Wash effect false triggers	<p>Device is mounted to close to other objects</p>	<p>Correct the mounting position</p> <p>Remove nearby objects</p>

IØ.4 Third party system integration issues

Symptom	Probable cause	Solution
One or both systems no longer operate	Bus contention (incompatibility)	Install a suitable conversion gateway/interface (for example, a DTK622-232).
Dynalite controls operate intermittently	Third party system (such as such as AMX, DMX or Crestron) is streaming messages and overriding DyNet.	Install a suitable conversion gateway/interface (for example, a DTK622-232). Disable or isolate DMX.



Safety Notice: To ensure safety and prevent damage to the system, appropriate isolation shall be provided. Only SELV/Class 2 (UL) systems shall be connected to non-isolated DyNet interfaces.

II Pre-commissioning site visit

II.1 Visit details

Date:	Project:
Expected Commissioning Start Date:	
Expected Commissioning Completion Date:	
Technician:	
Sales Rep:	

II.2 Installation Checklist

No.	Description	Yes	No
1	All products quoted have been received.		
2	All equipment is mounted as per installation instructions.		
3	Segregation between data and mains cables.		
5	Devices are connected in a daisy chain.		
6	Checked data cable terminations in multiple locations.		
7	Correct colour codes are used for data cable terminations		
8	Tested correct network voltages on each spur segment – [12V] – [D+] – [D-]		
9	If user interfaces are installed, test (Preset 1 & 4) for all ON/OFF		
10	Verified sensor wiring before commissioning. Factory default sensor LED blinks when messages to area 1 are received.		
11	Slaving of shield wire to avoid short circuits.		
12	Checked bridge/gateway connections for trunk and spur Topology		
13	If 0-10V drivers are used, polarity is maintained when terminating 'Figure-8' cables.		
14	Record Dynalite equipment serial numbers on a clean set of floor plan drawings		
15	On the same set of floor plan drawings, add how the data cable was run.		
16	Provide a schedule indicating the circuit allocation to each dimmer/relay channel and include a brief description of the load.		
17	An architectural drawing with room names or numbers		
18	Go through the electrical specification (make sure all parties have the same understanding)		
19	Is a site induction required?		
20	Is protective equipment required?		
21	Will the Electrical Contractor or a representative be still available after 3:30pm (Note That Dynalite trading hours are from 8:30am – 5:00pm)		
22	What 'as-built' documentation is required for the final handover?		
23	Are we required to demonstrate system operation to the Client?		
24	Are button functions, presets, schedules, light regulation and sensor timeouts working as specified in each area?		

II.3 Site contacts

Builder

Name:

Project
Manager:

Mobile:

Supervisor:

Electrical Contractor

Name:

Project
Manager:

Mobile:

Supervisor:

System Integrator

Name:

Project
Manager:

Mobile:

Supervisor:

Electrical Consultant

Name:

Project
Manager:

Mobile:

Supervisor:

Client

Name:

Project
Manager:

Mobile:

Supervisor:

R10, 5 March 2026
www.dynalite.com